

Sauna da giardino

LAVA

345 x 234 x 260 cm

ISTRUZIONI DI MONTAGGIO

Italiano



IT

Indice

1. Preparazione per il montaggio	3
1.1. Indicazioni importanti	3
1.2. Fondamenta	4
1.3. Ancoraggio della sauna all'aperto	4
1.4. Attrezzi necessari	4
1.5. Manutenzione e pulizia	6
1.6. Smaltimento	6
2. Pianta/fondamenta	7
3. Montaggio cabina	8
3.1. Montaggio telaio di base	8
3.2. Montaggio delle pareti della cabina	8
3.3. Montaggio della porta	8
3.4. Finestre di montaggio	8
3.5. Montaggio delle pareti	8
3.6. Montaggio del tetto a falda unica	9
3.7. Montaggio delle aste filettate	9
3.8. Montaggio degli elementi del tetto della sauna	9
3.9. Montaggio del tetto esterno	9
3.10. Copertura del tetto	9
3.11. Montaggio del pavimento	10
3.12. Montaggio dell'allestimento interno	10
3.13. Montaggio della porta interna	10
3.14. Montaggio accessori	10
Figura Misure (dopo l'ultima lingua)	11
Elenco dei pezzi (dopo l'ultima lingua)	12
Figure di montaggio (dopo l'ultima lingua)	16

1. Preparazione per il montaggio

Leggere con attenzione le presenti istruzioni di montaggio e conservarle. In questo modo è possibile controllare in qualsiasi momento le informazioni relative al prodotto.



Le presenti istruzioni di montaggio sono disponibili anche nella sezione download del nostro sito web all'indirizzo: www.piscineitalia.it

1.1. Indicazioni importanti

- Informatevi presso l'autorità edilizia competente locale (ufficio comunale o autorità comunali) per i regolamenti edilizi e gli standard di carico.
- Solide fondamenta in cemento sono importanti per la durata e la sicurezza della vostra sauna all'aperto. Vi consigliamo di far eseguire le fondamenta da un professionista.
- L'ancoraggio della sauna esterna è responsabilità del cliente. Nessuna garanzia in caso di danni.
- La sauna all'aperto è consegnata da un camion (eventualmente anche da un autoarticolato). Di conseguenza è necessario assicurarsi che sia possibile l'accesso al luogo di scarico.
- Prima di iniziare i lavori, controllare in base all'elenco dei pezzi se tutti i singoli componenti sono stati effettivamente forniti. Se eccezionalmente dovessero mancare dei singoli componenti, contattare il proprio fornitore entro 14 giorni dal ricevimento della cabina.
- Conservate la bolla di consegna, la fattura e le istruzioni di montaggio in un luogo sicuro per eventuali domande.
- Per il montaggio è richiesto l'aiuto di una seconda persona.
- Tutte le connessioni a vite devono essere preforate.



Attenzione!

Il collegamento elettrico deve essere eseguito da elettricisti specializzati o da persone con una qualifica simile.

- Il cartone catramato in dotazione serve come copertura iniziale. Si consiglia di coprire ulteriormente il tetto con tegole bituminose, lamiera o una lamina adatta.
- Il legno è un prodotto naturale che può gonfiarsi, ritirarsi o deformarsi anche se immagazzinato correttamente. In fase di montaggio potrebbe quindi essere necessario applicare una certa forza.

- Il legno della sauna esterna non è trattato. Per aumentare la durata di vita, si consiglia di dipingere l'esterno con una vernice protettiva per legno adatta.
- I componenti in legno da utilizzare all'interno non devono essere trattati con vernice.

1.2. Fondamenta

I seguenti elementi per le fondamenta hanno dimostrato la loro efficacia nella pratica:

- piastra di fondazione (piastra di base)
- striscia di fondazione

Con entrambe le varianti, devono essere garantite fondamenta perfettamente orizzontali e portanti. Solo in questo modo è possibile garantire una perfetta installazione della sauna esterna con un adattamento esatto.

Si consiglia di usare del nastro di catrame (foglio impermeabilizzante) tra il legno del basamento e il cemento per evitare che l'umidità penetri nel legno.

1.3. Ancoraggio della sauna all'aperto

È molto importante che la sauna all'aperto sia saldamente ancorata alla piastra di fondo o alla striscia di fondazione. In caso di vento forte, grandi forze possono agire sulla casetta da giardino. Per evitare danni alla vostra proprietà o a quella di altri, un ancoraggio professionale è assolutamente necessario.

Vorremmo sottolineare che l'ancoraggio della casetta da giardino è di responsabilità del cliente e non ci assumiamo nessuna responsabilità per eventuali danni.

1.4. Attrezzi necessari

- Martello, pezzo di legno e martello in gomma
- Avvitatore elettrico con punte per viti con testa a croce e viti Torx
- Metro a nastro avvolgibile
- Punta per trapano da 4 mm, 5 mm, 6 mm, 20-30 mm (per cavo elettrico della stufa per sauna)
- Livella a bolla
- Chiave fissa da 17 mm
- Cutter
- Scala
- Sega



Questo simbolo indica consigli e indicazioni utili



Preforatura



Taglio alla lunghezza effettiva



Inchiodamento



Cablaggio



Verifica dell'ortogonalità:

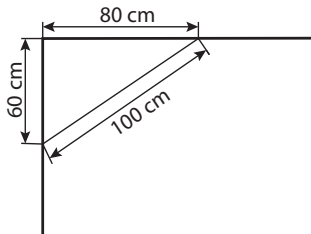

Maneggiare il vetro con cura: particolare attenzione deve essere prestata ai bordi del vetro - il vetro temprato può frantumarsi in piccoli pezzi in caso di impatto. Inserire un cuscino di protezione (ad es: scatola di cartone) sotto il bordo del vetro.

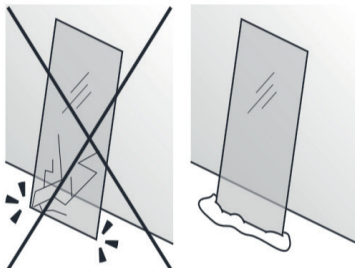

1.5. Manutenzione e pulizia

- La sauna all'interno deve essere pulita con un panno umido. Utilizzare solo acqua calda senza detersivi.
- Se la sauna non viene utilizzata per un tempo prolungato, si consiglia di riscaldare la cabina una volta al mese.



Le tasche di resina non sono motivo di reclamo perché nel legno di abete rosso sono sempre presenti e durante la selezione non è possibile rilevare a quale profondità si trovino.

Quando sono appena al di sotto della superficie, con lo sviluppo del calore si rompono e possono "essudare".

Rimuovere la resina fuoriuscita con un panno imbevuto di acetone.

Se sono presenti solo gocce di resina, lasciarle indurire e poi raschiarle con cautela usando un coltello.

1.6. Smaltimento



- Smaltire i materiali dell'imballaggio conformemente alle normative sullo smaltimento vigenti.



2. Pianta/fondamenta

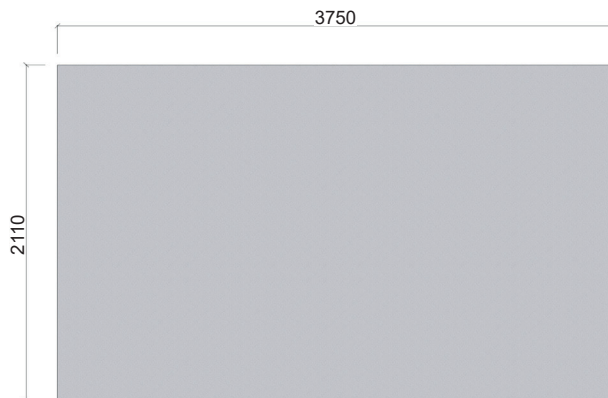
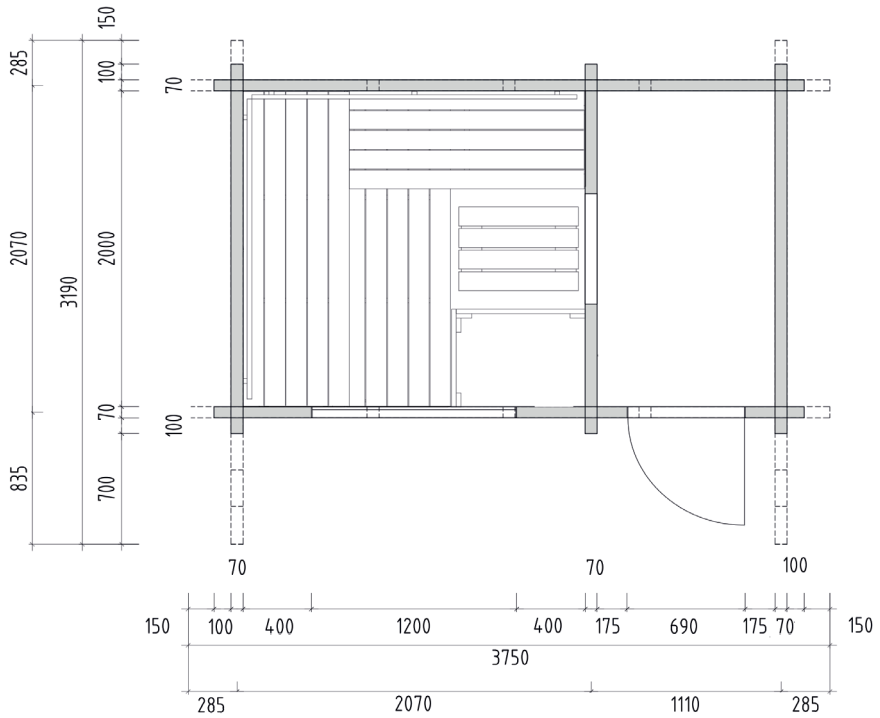

3. Montaggio cabina



ATTENZIONE!

Osservare la pianta a Pagina 7 e le figure da Pagina 11.

3.1. Montaggio telaio di base

Posizionare il telaio di base impregnato sulle fondamenta come mostrato nella pianta e nelle immagini delle fondamenta (vedi Pagina 7).



Verificare che il telaio di base sia montato ad angolo retto.

Osservare l'alimentazione elettrica!

3.2. Montaggio delle pareti della cabina



Le travi per parete sono sempre montate insieme con la molla rivolta verso l'alto.

Non colpire MAI la molla direttamente con il martello!

Iniziare a posare le mezze travi della parete anteriore e della parte posteriore sul telaio di base e poi posizionare le travi laterali.

Collegare le travi per Blockhaus alle fondamenta in cemento in corrispondenza degli angoli (vedi 1.3 a pagina 4).

Continuare fila per fila - fino alla fila 7 inclusa. Osservare la posizione del cursore di ventilazione nella fila 2 e le travi per Blockhaus con i fori per l'installazione elettrica.

3.3. Montaggio della porta

Il telaio della porta viene inserito dall'alto nell'apertura (apertura della porta verso l'esterno).

Montare la cerniera della porta.

3.4. Finestre di montaggio

Montare le rimanenti travi per Blockhaus - fino alla fila 12 compresa.

Per prima cosa, montare i listelli di bordo sulla finestra. Far scorrere la finestra nell'apertura dall'alto.

3.5. Montaggio delle pareti

Montare le rimanenti travi per Blockhaus - fino alla fila 18 compresa.

Osservare il posizionamento delle travi per Blockhaus con i fori per il cablaggio.

Avvitare il rivestimento della porta e della finestra internamente ad angolo retto.

3.6. Montaggio del tetto a falda unica

Inserire gli elementi del tetto a falda unica a destra e a sinistra. Rimuovere le travi per Blockhaus superiori inclinate per inserire le tavole per Blockhaus nella parte anteriore.

3.7. Montaggio delle aste filettate

Collegare le aste filettate tra loro come da figura e inserirle dall'alto negli appositi fori delle travi per Blockhaus.

Avvitare la flangia sul lato superiore e fissare le rondelle e i dadi sul lato inferiore.

Poi montare l'elemento centrale del tetto a falda unica e l'asta filettata corrispondente.

Predisporre i fori per l'impianto tecnico (stufa per sauna, comando,...).

3.8. Montaggio degli elementi del tetto della sauna

Montaggio dei listelli di supporto del tetto.

Inserire gli elementi del tetto.



Eseguire l'installazione elettrica - inserire i cavi!

Se gli elementi del tetto vengono avvitati dall'alto, non sarà più possibile accedere all'intercapedine del tetto. Potrebbe quindi essere necessario tagliare un'apertura di ispezione nel frontone del tetto per l'impianto tecnico.

3.9. Montaggio del tetto esterno

Posizionare i falsi puntoni nelle cavità come da figura e avvitarli alle travi per Blockhaus.

Fissare le perline maschio-femmina ai falsi puntoni iniziando dal lato posteriore. Battere leggermente le perline fra loro e inchiodarle ai falsi puntoni. Assicurarsi che le perline siano costantemente parallele!

Le tavole del tetto devono essere a filo con i falsi puntoni sul lato anteriore e posteriore – se necessario, accorciare le tavole.

3.10. Copertura del tetto

Iniziare la posa del cartone catramato come da figura sul lato inferiore del tetto (40 mm di sporgenza).

Montaggio delle tavole del bordo tetto e delle cornici del bordo tetto.

3.11. Montaggio del pavimento

Posizionare le tavole del pavimento sul telaio del pavimento e fissarle a quest'ultimo.



Garantire una distanza di 5 mm dalle pareti in modo che le tavole possano dilatarsi in caso di sbalzi di temperatura!

Accorciare i battiscopa alla lunghezza effettiva e fissarli alle travi per Blockhaus ma non alle tavole del pavimento!

3.12. Montaggio dell'allestimento interno

Montaggio del pannello scorrevole di aerazione.

Montare i listelli di supporto delle panche come da figure.

Innanzitutto inserire le panche superiori e avvitarle insieme.

Posizionare la panca inferiore sui listelli di supporto.

Fissare il pannello di rivestimento della panca e gli schienali come da figure.

3.13. Montaggio della porta interna

Per prima cosa montare le tavole del bordo sul telaio della porta (lato anticamera).

Posizionare la porta interna dell'anticamera nell'apertura della porta e fissarla montando il rivestimento della porta dal lato interno della sauna.









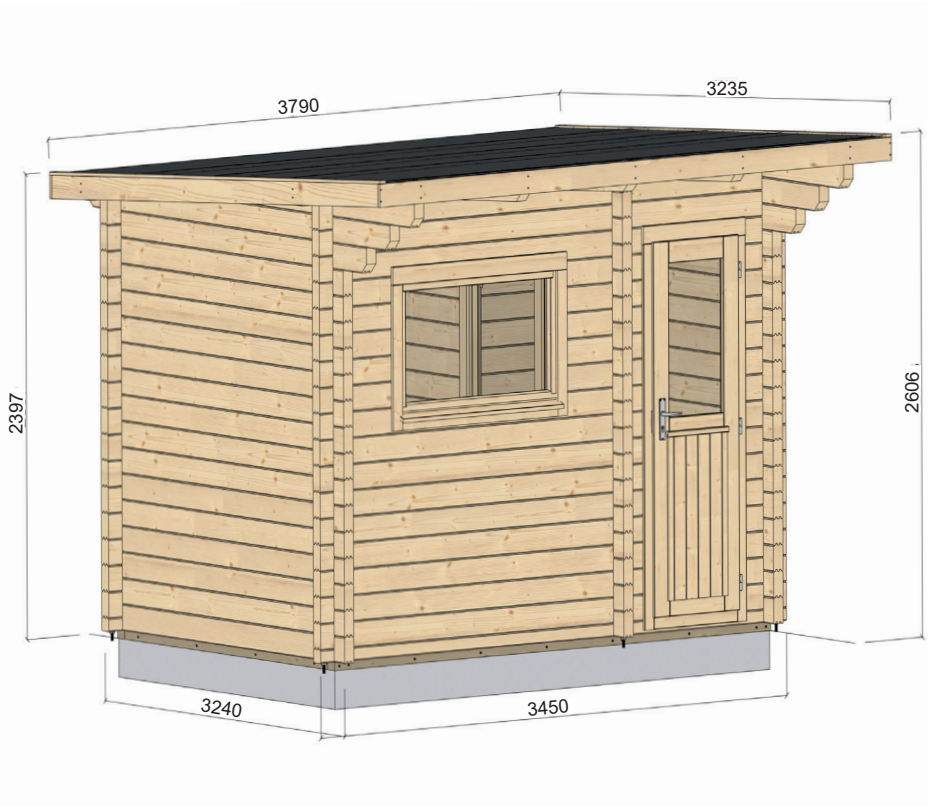

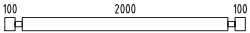
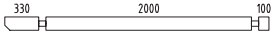
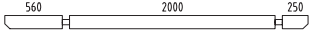
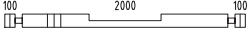

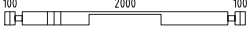
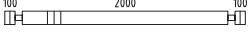
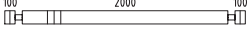
3.14. Montaggio accessori

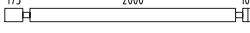
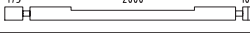

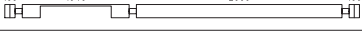
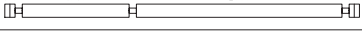
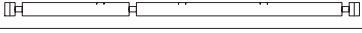
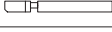

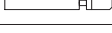

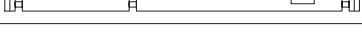



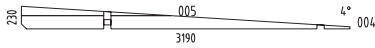
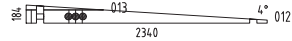
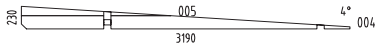

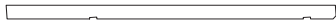





Montaggio della griglia di protezione della luce e della lampada.







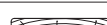

















Montaggio della griglia di protezione della stufa.

Montaggio della griglia di ventilazione all'esterno.









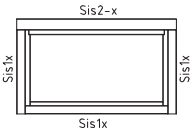
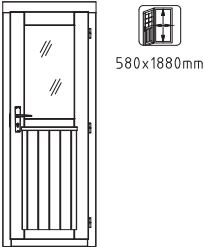
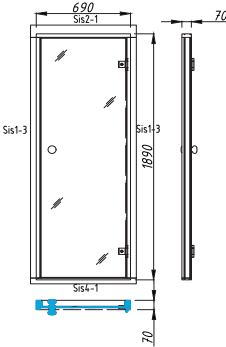

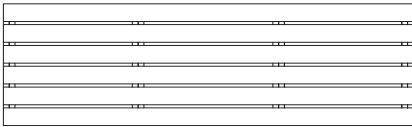
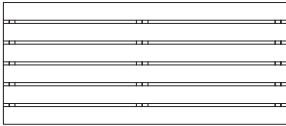
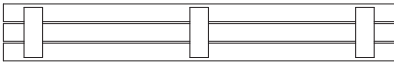
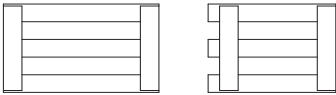
Pos	SPECIFICATION-STÜCKLISTE-NOMENCLATURE-ELEMENTI-ESPECIFICACIÓN	Pcs	Profile (mm)	Length (mm)
001		30	70x135	2340
002		2	70x135	2570
003		2	70x135	2950
006		1	70x135	2340
007		13	70x135	820
008		13	70x135	820
009		1	70x135	2340
010		1	70x135	2340
011		1	70x135	2340
014		1	70x68	3450
015		14	70x135	345
016		8	70x135	2415
017		1	70x135	2415
018		5	70x135	645
019		5	70x135	570
020		1	70x135	3450
021		15	70x135	3450
022		1	70x135	3450
023		2	70x110	1045
024		2	70x110	725
025		2	70x110	725
026		2	70x110	1045
027		1	70x68	3450
028		1	70x135	3450
029		1	70x135	3450

Pos	SPECIFICATION-STÜCKLISTE-NOMENCLATURE-ELEMENTI-ESPECIFICACIÓN	Pcs	Profile (mm)	Length (mm)
W1-1		1		
W2-1		1		
W3-1		1		
AR1	Foundation- Fundament- Fondation- Fondazione- Vigas de cimentación 	2	70x45	3230
AR2	Foundation- Fundament- Fondation- Fondazione- Vigas de cimentación 	10	70x45	1980
RoR1	Rafter- Sparre- Chevron- Trave- Cabrio 	3	70x140	3204
SP1	Support brace- Stützleiste- Baguette de support- Listello di supporto- Listón de soporte 	5	45x70	590
SP2	Support brace- Stützleiste- Baguette de support- Listello di supporto- Listón de soporte 	2	45x45	2000
SP3	Support brace- Stützleiste- Baguette de support- Listello di supporto- Listón de soporte 	2	45x45	1910
FB2-1	Floor board- Fussbodenbrett- Madrier du plancher - Tavola pavimento- Tabla de suelo 	23	89x19	1995
FB2-2	Floor board- Fussbodenbrett- Madrier du plancher - Tavola pavimento- Tabla de suelo 	23	89x19	1034
RB2-1	Roof board- Dachbrett- Madrier du toit- Tavola tetto- Tabla de tejado 	36	89x19	3750
FIB1-1	Floor beading- Fussbodenleiste- Baguette du plancher- Listello pavimento- Listón de suelo 	7	19x19	2050
EaE6-1	Eave edging- Dachrandbrett- Madrier en bordure du toit- Tavola bordo tetto- Tabla de valadizo 	2	19x120	3790
FaB7-1	Facia board- Giebelblende- Écran frontal- Schermo frontone- Tabla de facia 	2	19x120	3190
YPapp-1	Roof felt- Dachpappe- Carton bitume- Cartone catramato- Fieltro de tejado 	4		4000
Sis4-1	Side slat- Randleiste- Baguette en bordure- Listón de borde- Listello bordo 	2	19x45	900
Sis1-1	Side slat- Randleiste- Baguette en bordure- Listón de borde- Listello bordo 	4	19x70	713
Sis1-2	Side slat- Randleiste- Baguette en bordure- Listón de borde- Listello bordo 	2	19x70	1154
Sis1-3	Side slat- Randleiste- Baguette en bordure- Listón de borde- Listello bordo 	4	19x70	1960
Sis2-1	Side slat- Randleiste- Baguette en bordure- Listón de borde- Listello bordo 	2	19x95	900
Sis2-2	Side slat- Randleiste- Baguette en bordure- Listón de borde- Listello bordo 	2	19x95	1294
WB1-1	Wind brace- Windbrett- Madrier contre le vent- Tavola vento- Tabla contra el viento 	2	16x45	3230

Pos	SPECIFICATION-STÜCKLISTE-NOMENCLATURE-ELEMENTI-ESPECIFICACIÓN	Pcs	Profile (mm)	Length (mm)
Fim	-Fixing kit - Befestigungsset - Moyens de fixation - Materiale di fissaggio - Kit de fijación	1	USE	
QULSI 30x35	Cylinder - Zylinderschloss - Serrure a mortaiser - Serratura a cilindro - Bombin - 30.35 	1	U70-76P	
QLIUHb	Door fittings- Türbeschlag- Ferrure- Ferramenta porta- Manilla puerta- QLIUHb 	1	U70-76P	
QULKAK	Door fittings- Türbeschlag- Ferrure- Ferramenta porta- Manilla puerta- QULKAK 	1	U70-76P	
QUN	Door fittings- Türbeschlag- Ferrure- Ferramenta porta- Manilla puerta- QUN 	1	U70-96P	
QNA1 4x40Me	Nail - Nagel - Clou - Chiodo - Clavo - 1.4x40mm 	50	FIB1-1	
QNA2 2x50Zn	Nail - Nagel - Clou - Chiodo - Clavo - 2.5x50mm 	200	FB2-1	
QNA3 x70Zn	Nail - Nagel - Clou - Chiodo - Clavo - 3x70mm 	200	RB2-1	
QNA2 x16Zn	Roofnail - Dachpappnagel - Clou pour carton bitumé - Chiodo di cartone castrato - Tachuela fieltro tejado - 2.0x16mm 	250		
QKRPP4 5x50Zn	Screw - Schraube - Vis - Vite - Tornillo - 4.5x50mm 	240	Dia-1.6x4.6-1F-A87-1,WB1-1 EL1; EL2; EL3 Rel-1-Rel1 Sis-x-x; 	
QKRPP4 5x70Zn	Screw - Schraube - Vis - Vite - Tornillo - 4.5x70mm 	60	014;027;004;005;012; 013 Rel-1+Wall EL3	
QKRPP5 x100Zn	Screw - Schraube - Vis - Vite - Tornillo - 5x100mm 	70	SP1; SP2; SP3 EL4; EL5; wall+PRx	
QKRP P6x1 20ZnTX	Screw - Schraube - Vis - Vite - Tornillo - 6x120mm TX 	10	004;005 012;013	
QKRPP6 x150Zn	Screw - Schraube - Vis - Vite - Tornillo - 6x150mm 	20	ARx	
QKRPP 8x220 kZnTX	Screw - Schraube - Vis - Vite - Tornillo - 8x220mm 	6	PRx	
KL1	Threaded rod - Gewindestangen - Barre fileté - Asta filettata - Varilla roscada M10 	6		2000
KL2	Threaded rod - Gewindestangen - Barre fileté - Asta filettata - Varilla roscada M10 	2		520
KL3	Threaded rod - Gewindestangen - Barre fileté - Asta filettata - Varilla roscada M10 	1		480
KL4	Threaded rod - Gewindestangen - Barre fileté - Asta filettata - Varilla roscada M10 	2		380
KL5	Threaded rod - Gewindestangen - Barre fileté - Asta filettata - Varilla roscada M10 	1		340
QMUk K10ZN	Nut - Schraubenmutter - Écrou - Dado - Tuerca - M10mm 	6		
QSE12 x35Zn	Washer - Dichtscheibe - Joint - Rondella - Arandela - 12x37mm 	6		
QMUJ 10ZN	Extension nut - Verlängerungsmutter - Écrou rallonge - Dado di prolunga - Tuerca de extensión - JM10 	6		
QMUP L10ZN	Top nut - Schweissmutter mit Flansch - Ecrou a souder - Dado a saldare - Tuerca soldable - M10 	6		

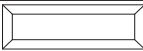
Pos	SPECIFICATION-STÜCKLISTE-NOMENCLATURE-ELEMENTI-ESPECIFICACIÓN	Pcs	Profile (mm)	Length (mm)
A70-69	<p>Window - Fenster - Fenetre - Finestra-Ventana 1190x685</p> 	1		
U70-76P	<p>Door - Tür - Porte - Porta-Puerta 680x1980</p> 	1		
U70-96P	<p>Door - Tür - Porte - Porta-Puerta 690x1890</p> 	1		

Pos	SPECIFICATION-STÜCKLISTE-NOMENCLATURE-ELEMENTI-ESPECIFICACIÓN	Pcs	Profile (mm)	Length (mm)
EL1		2	620x118	1990
EL2		1	620x118	1375
EL3		2	290x56	1900
EL4		1		
EL5		1		
EL6		1		
EL7		1		
Rel-1	Roof element - Dachelement - Panneau de toit - Elemento di tetto - Elemento tejado 	2	990x68	1990
QQ-Harvia	Light screen 	1		
	Interior light 			
	Ventilation shutter 			
	Silicon cable SIHF 5x2,5mm ² MMKSIHF2_5x5	1		3000
	Silicon cable SIHF 3x1,5mm ² MMKSIHF1_5x3	1		3000
	Ventilation shutte 	1		

3.1.

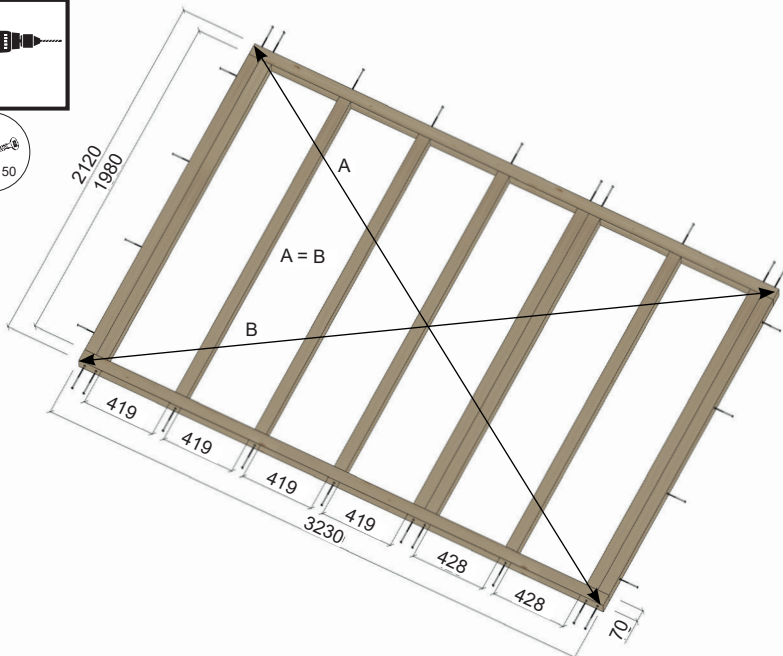
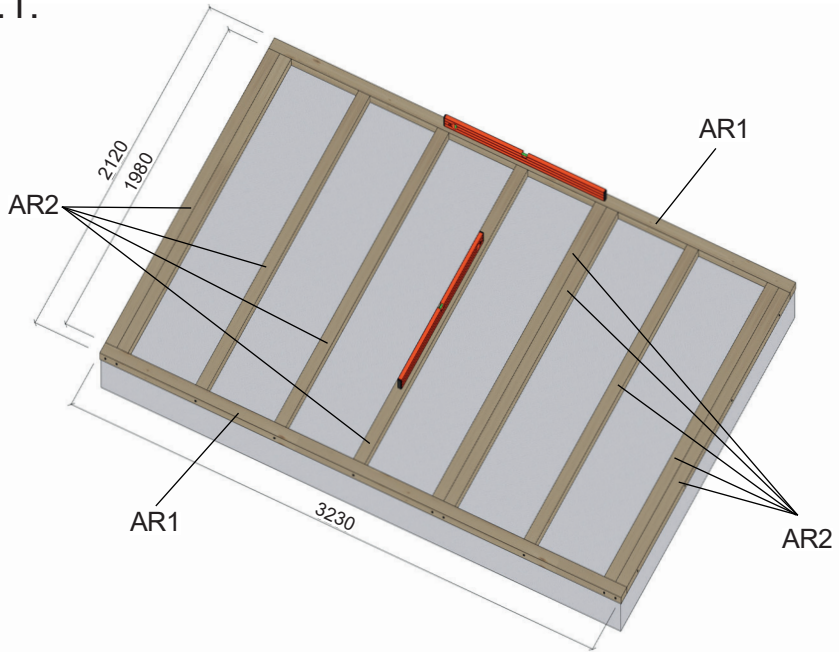

3.2.

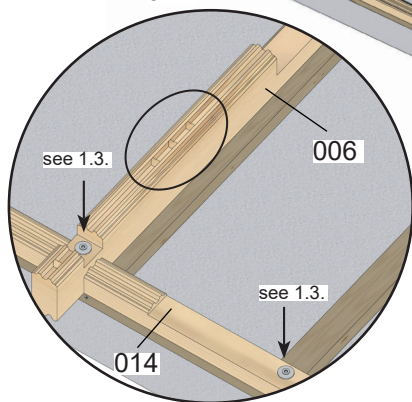
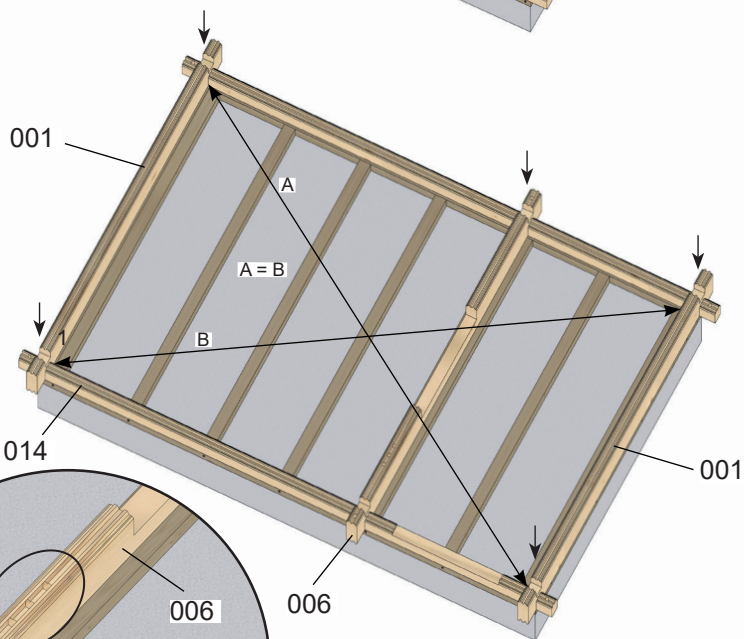
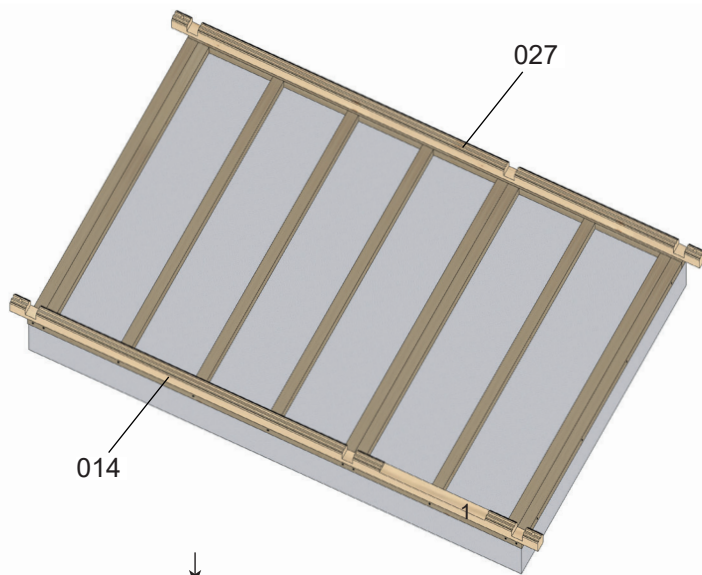

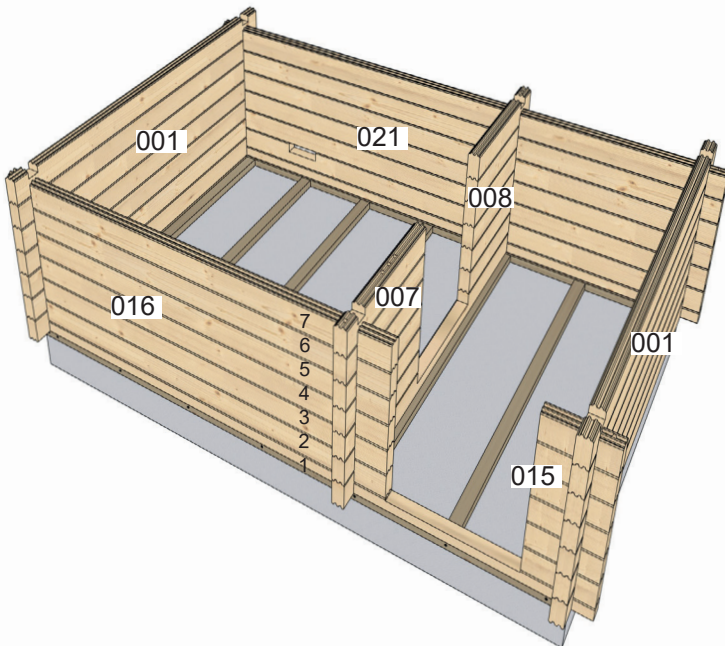
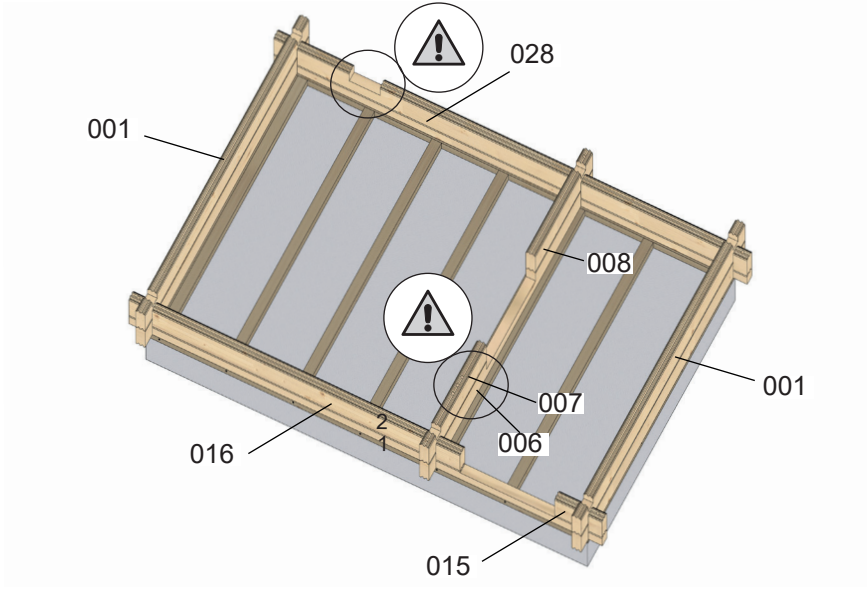

3.3.

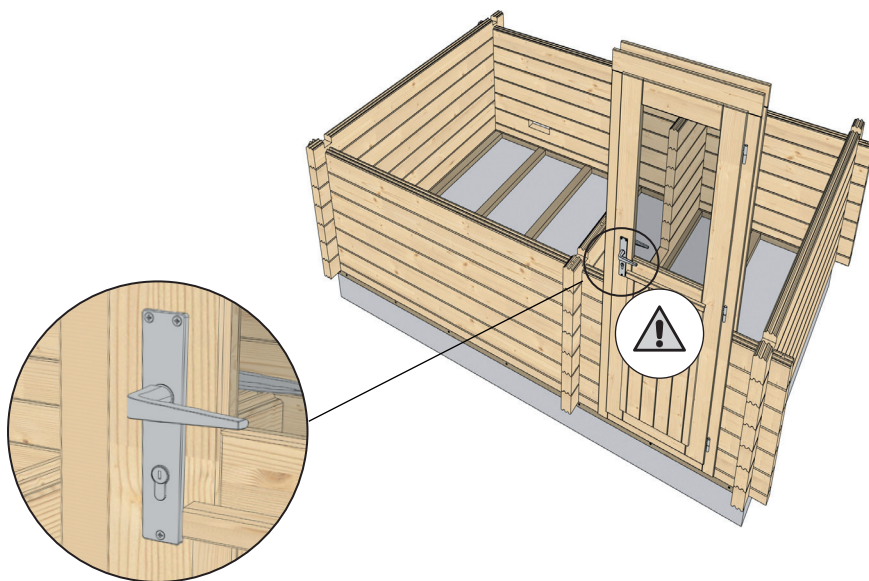
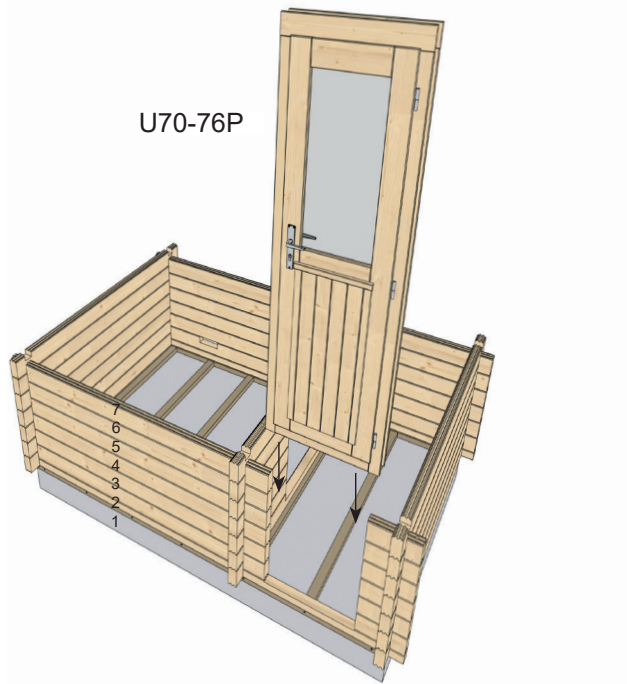

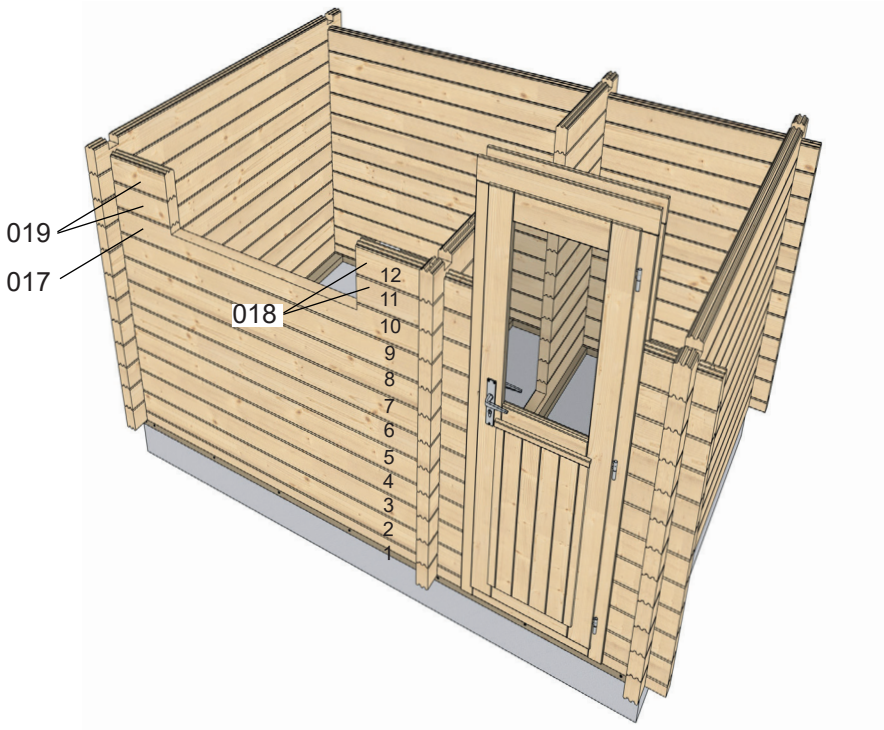

3.4.

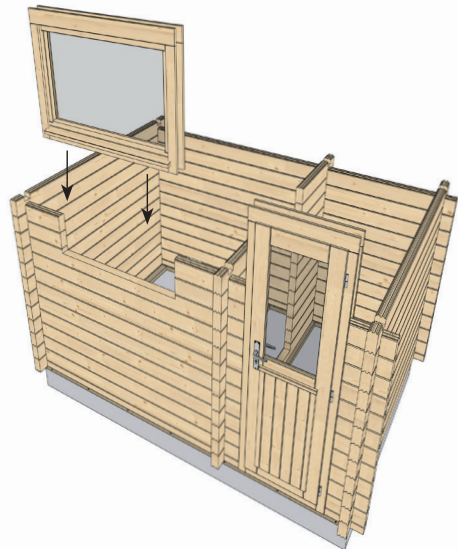
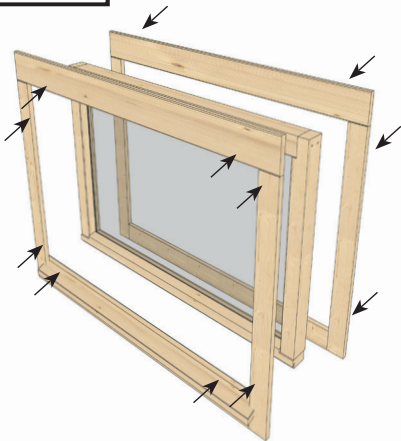

3.5

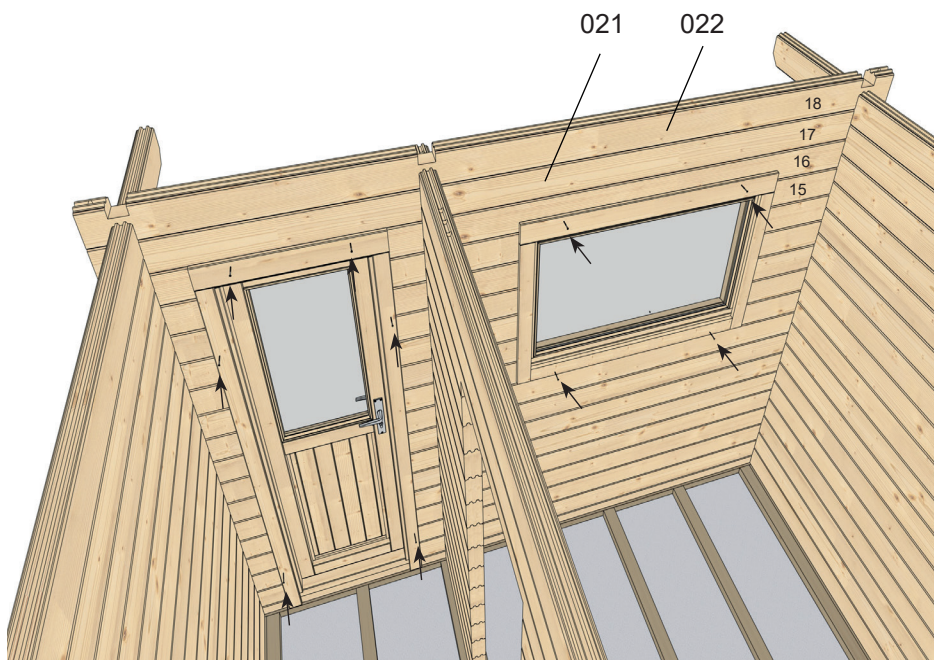
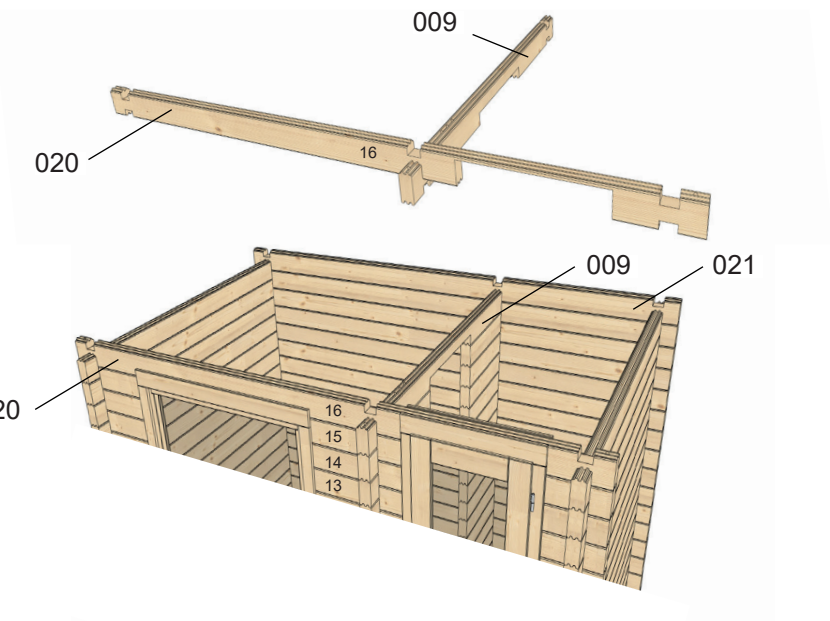

3.6.

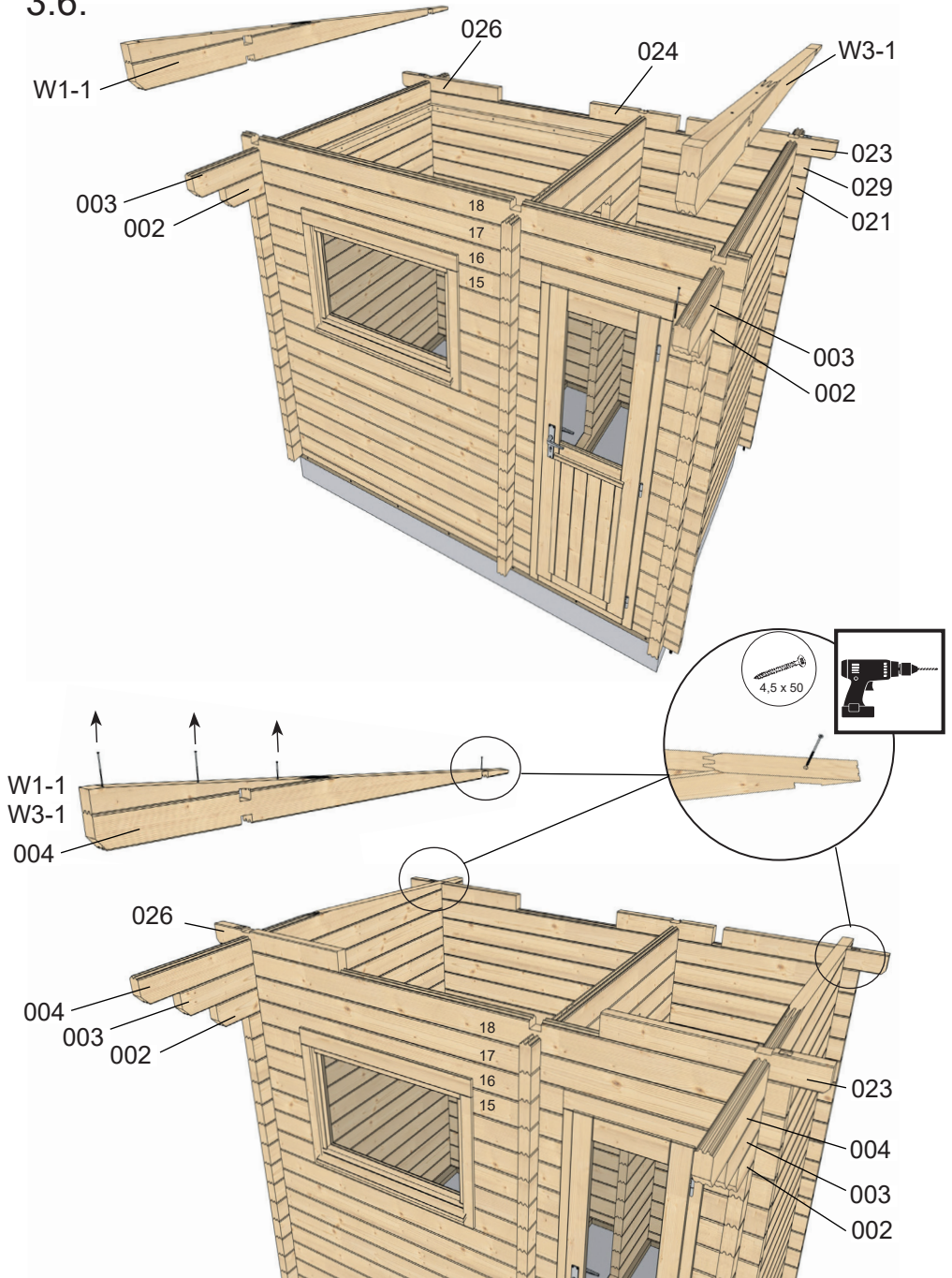

3.7.

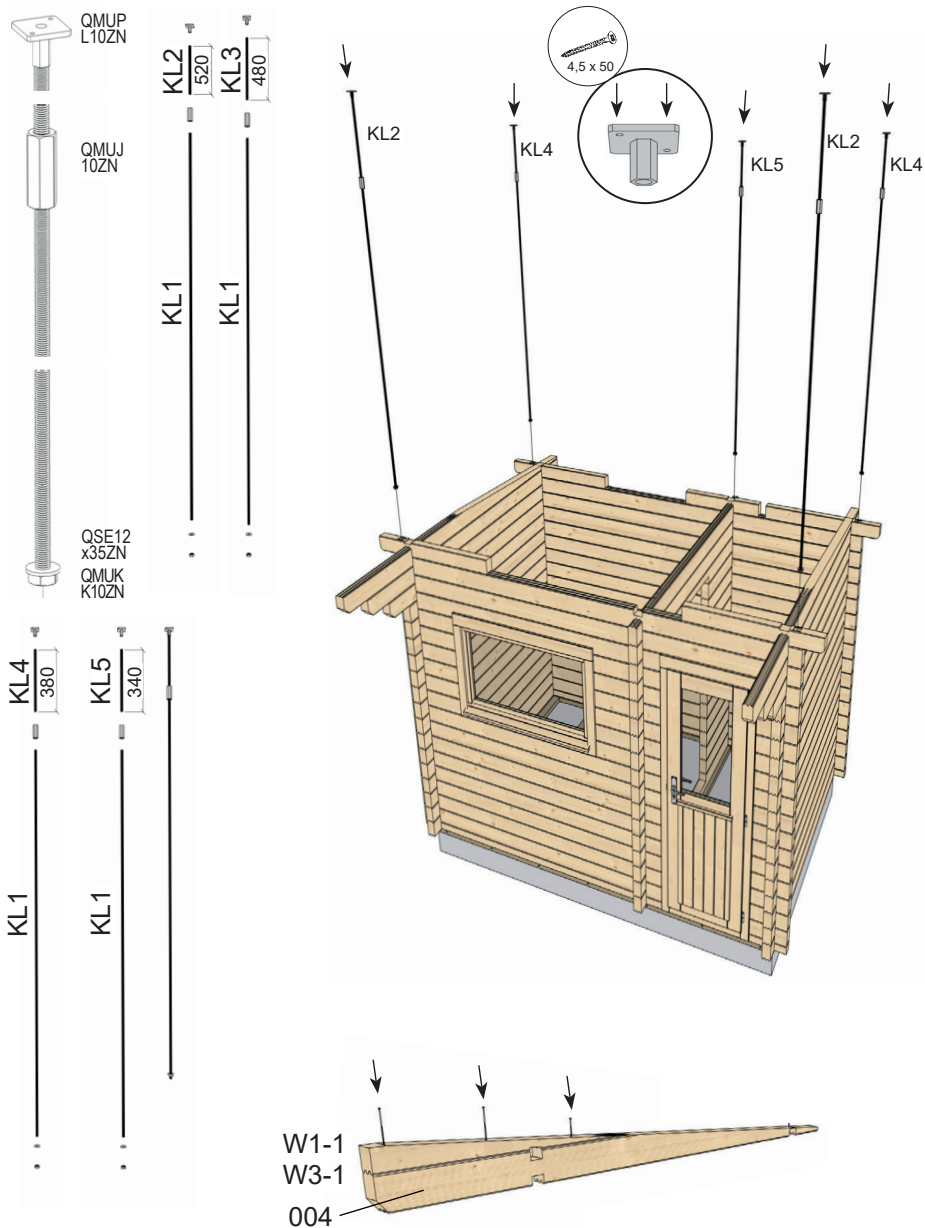

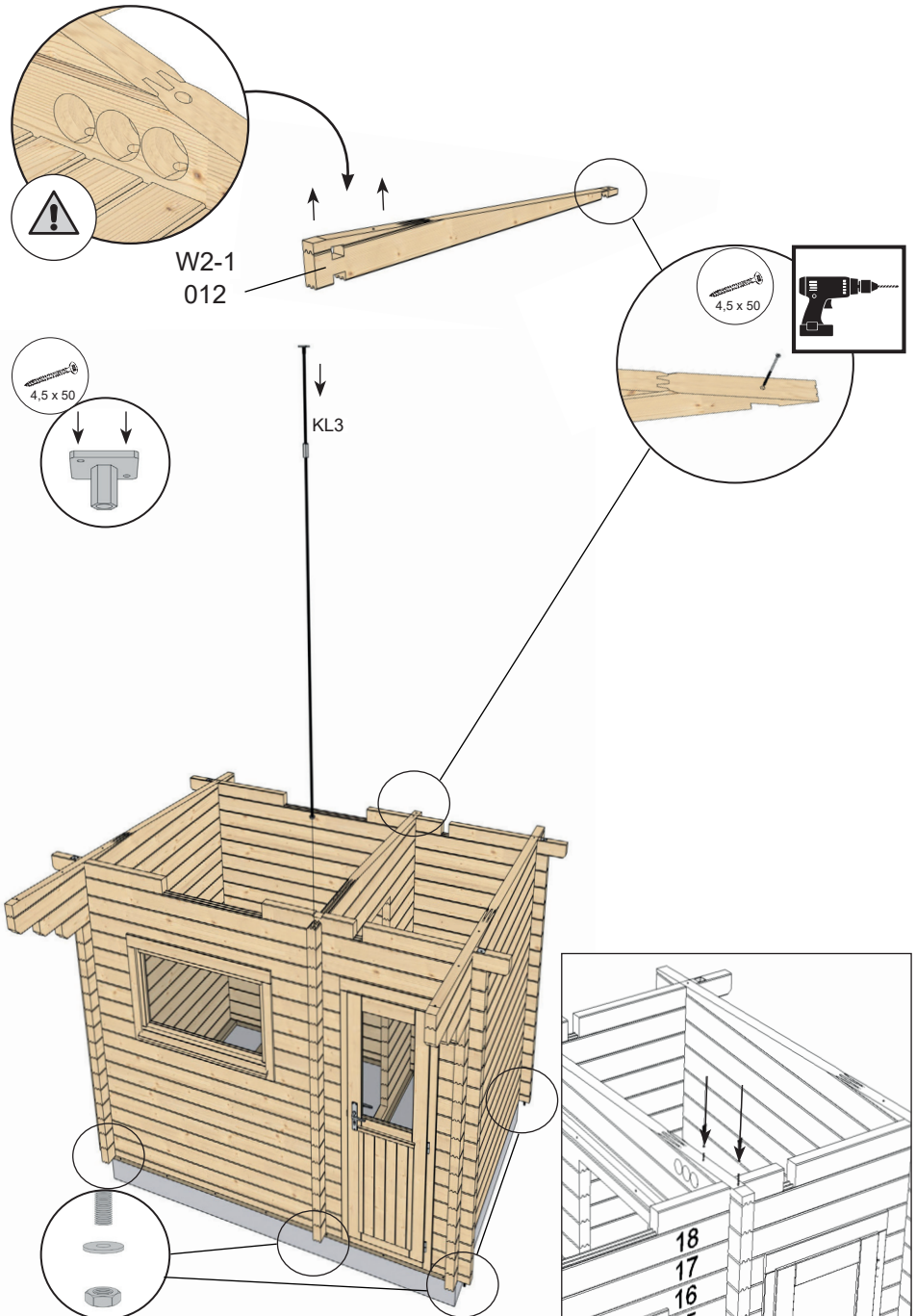

3.8.

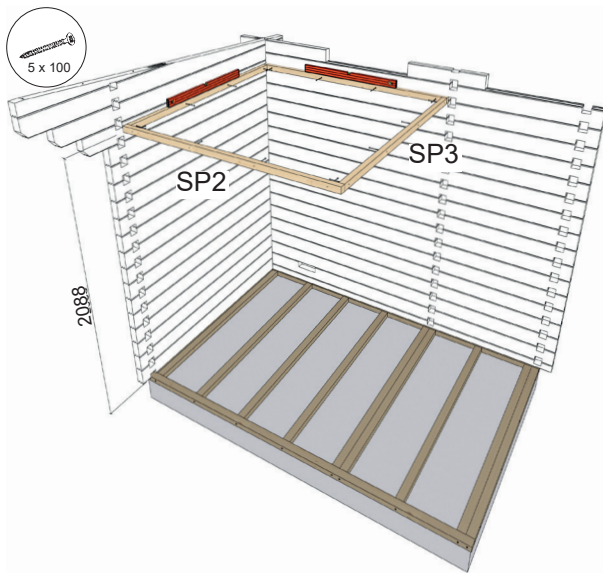
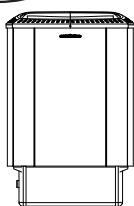
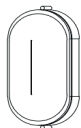
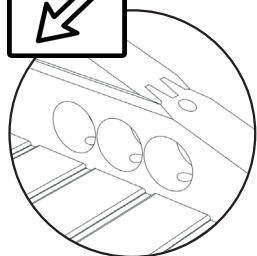

see 3.8.

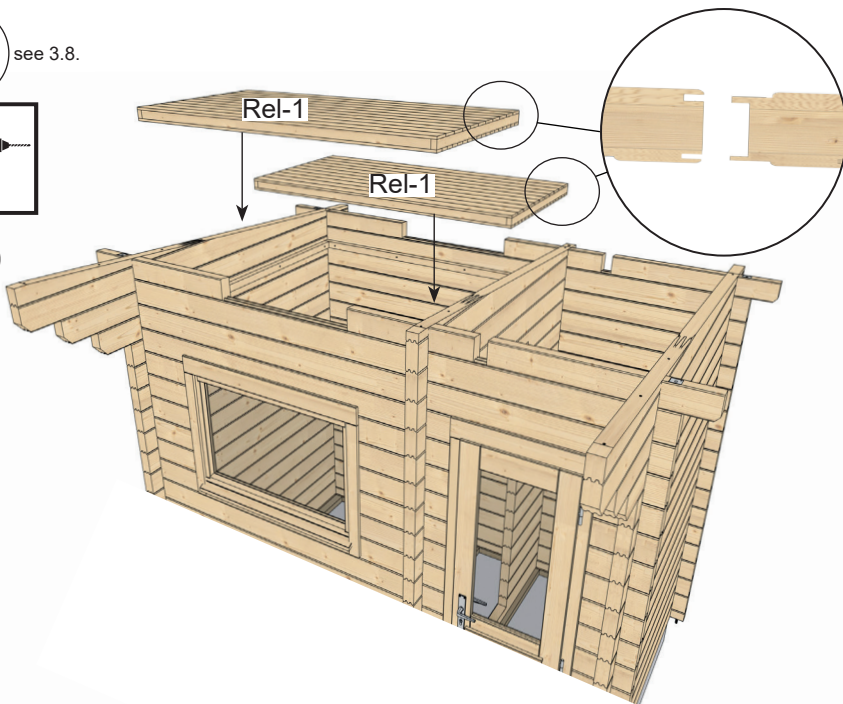

3.9.

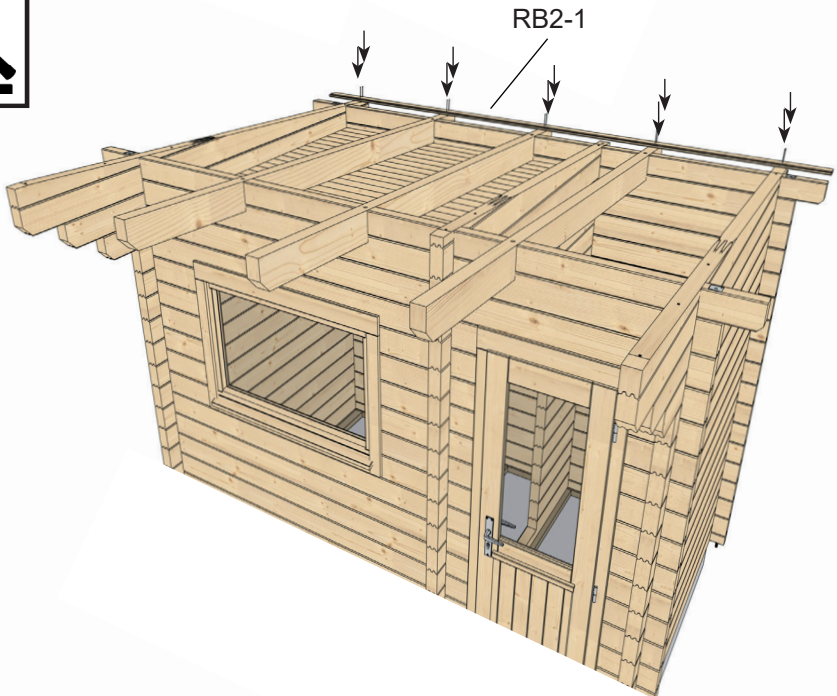
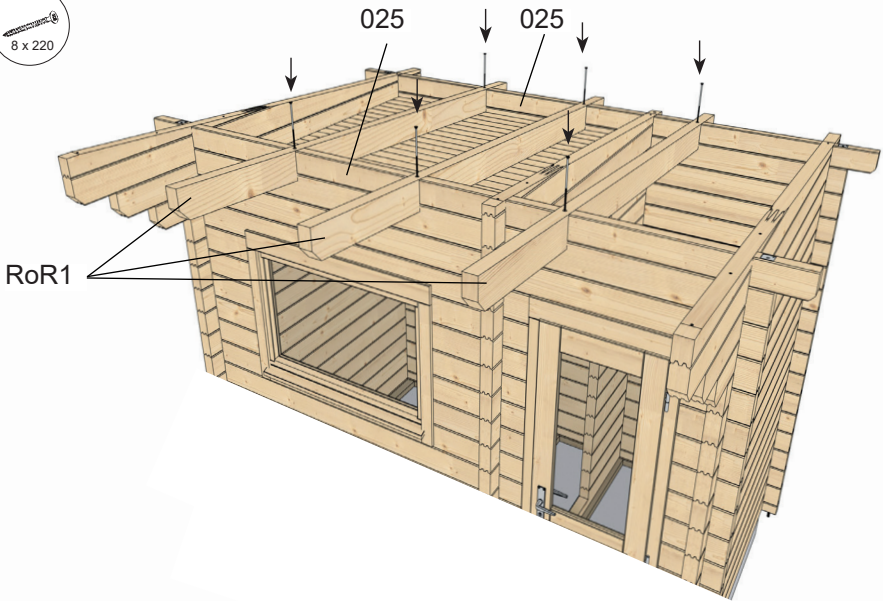

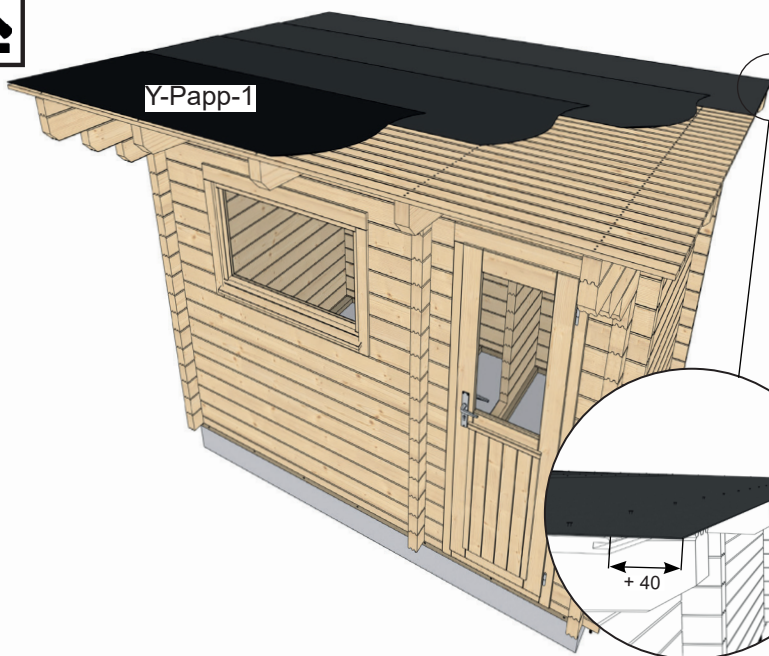
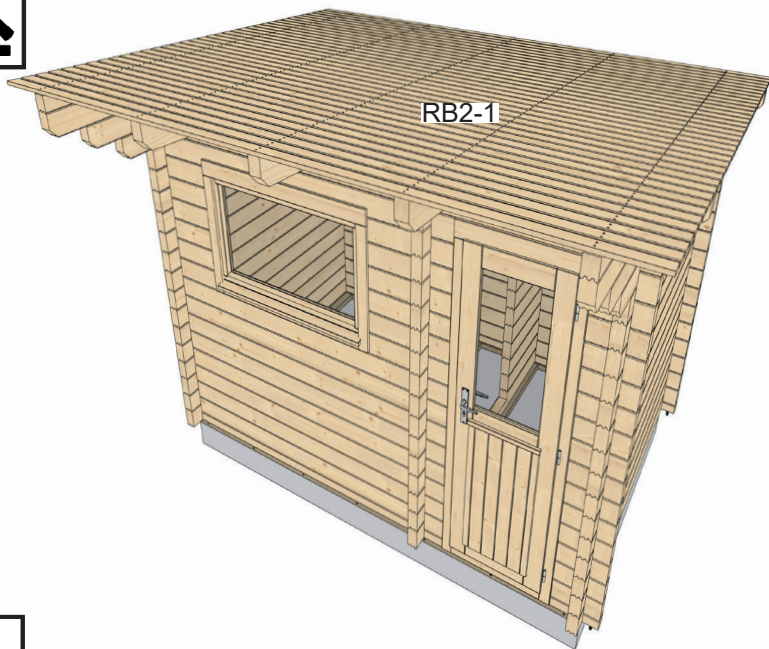

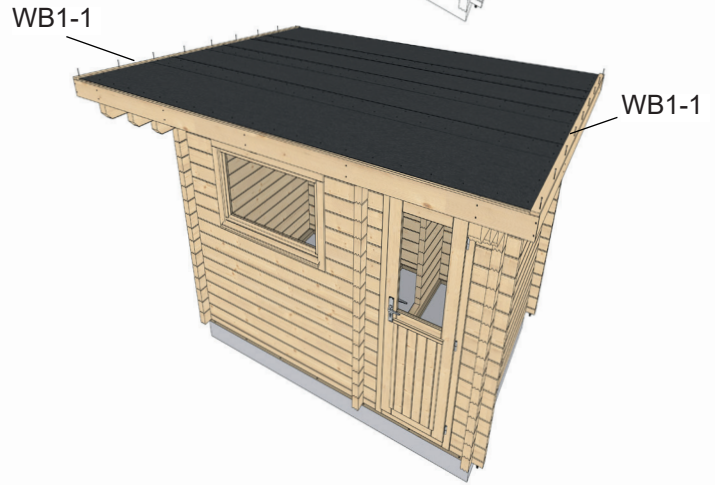
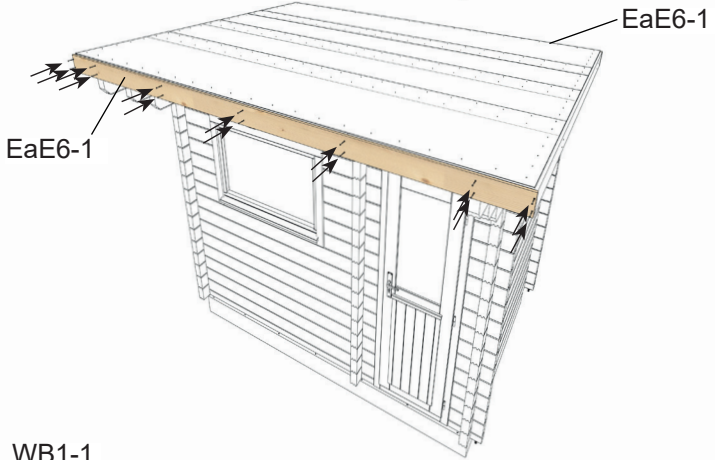
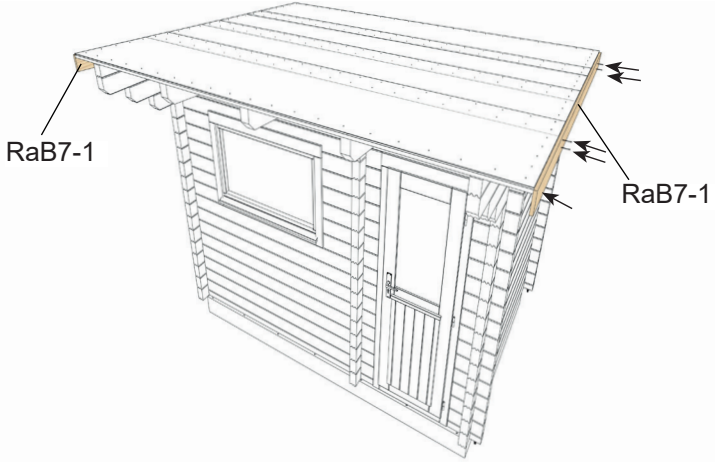

3.10.

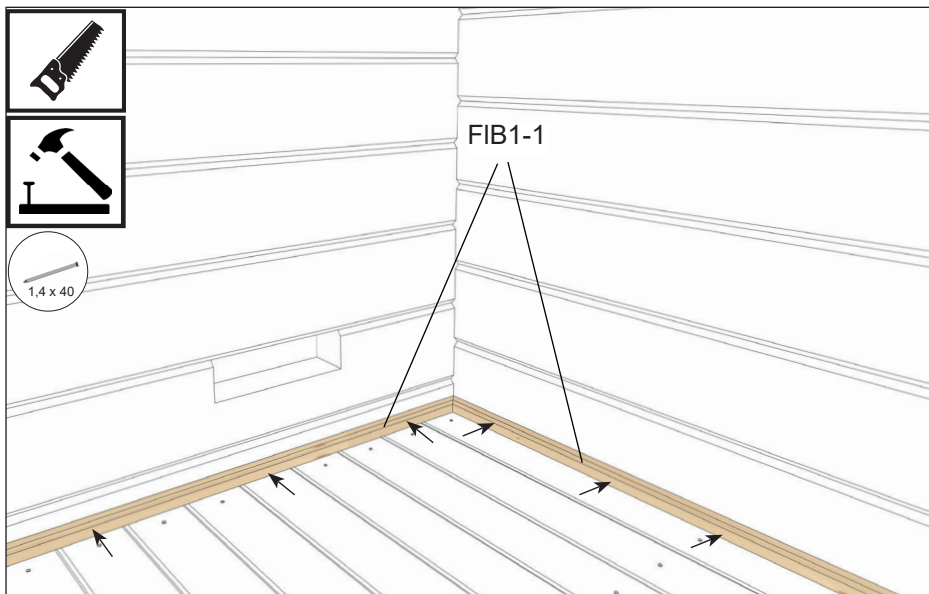
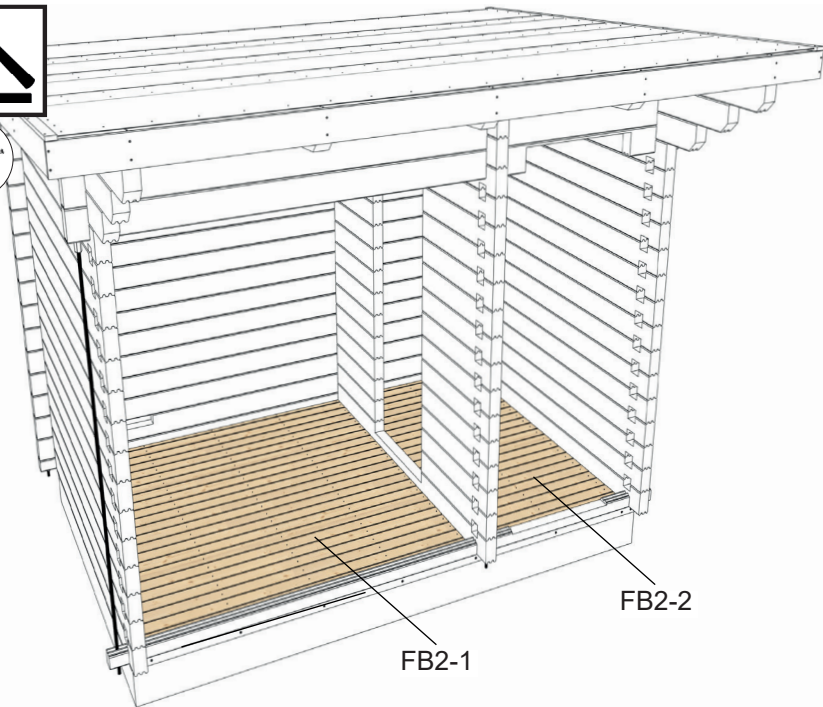

3.11.

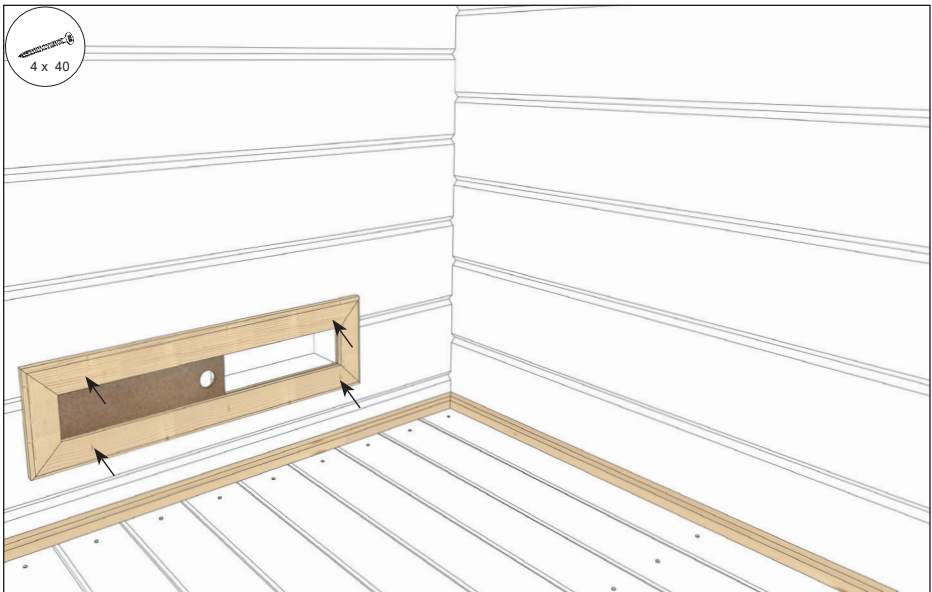
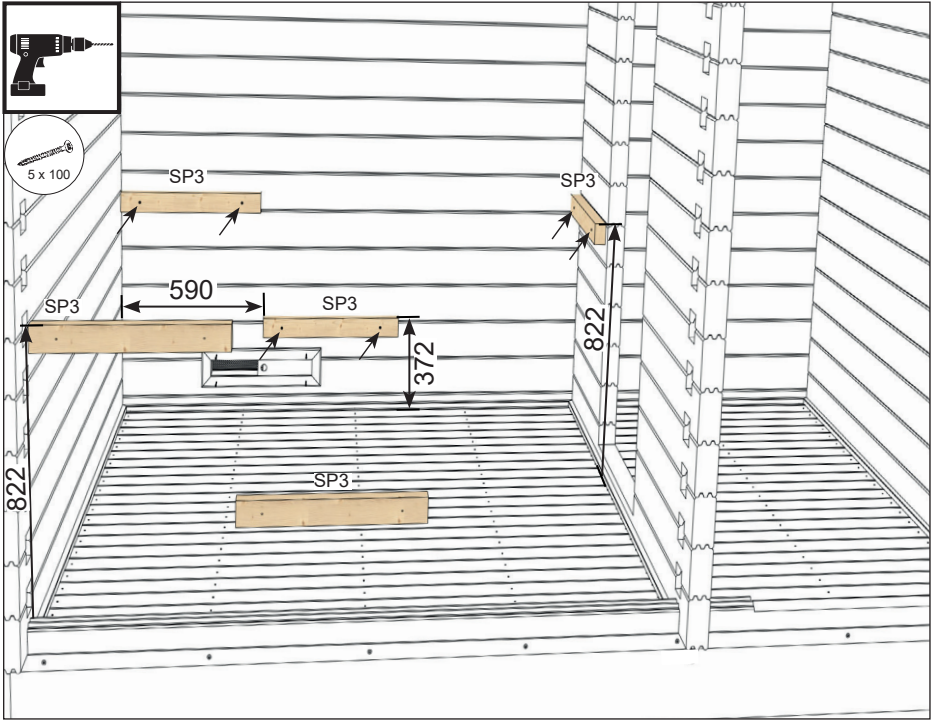

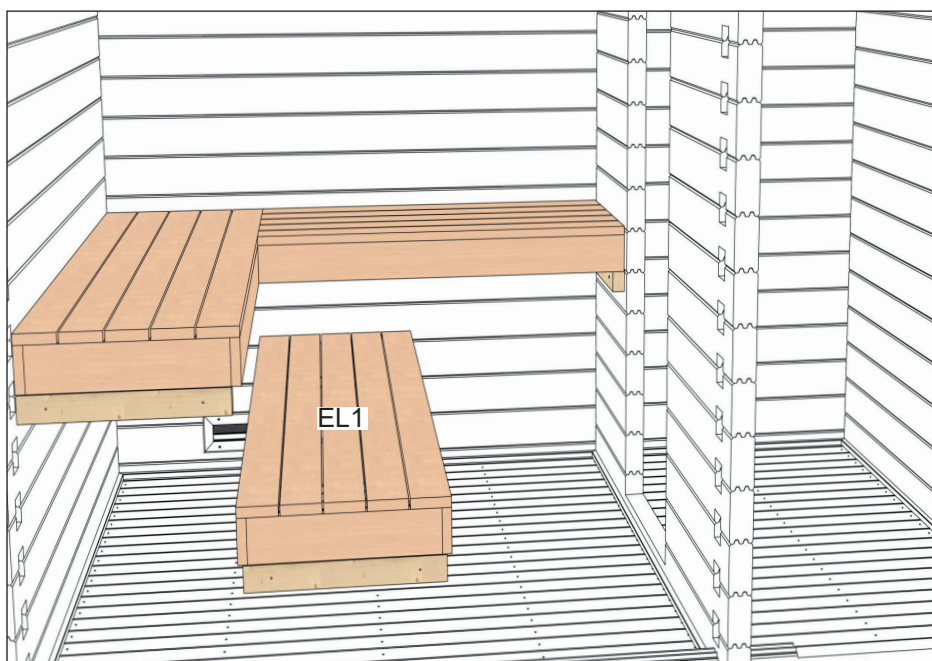
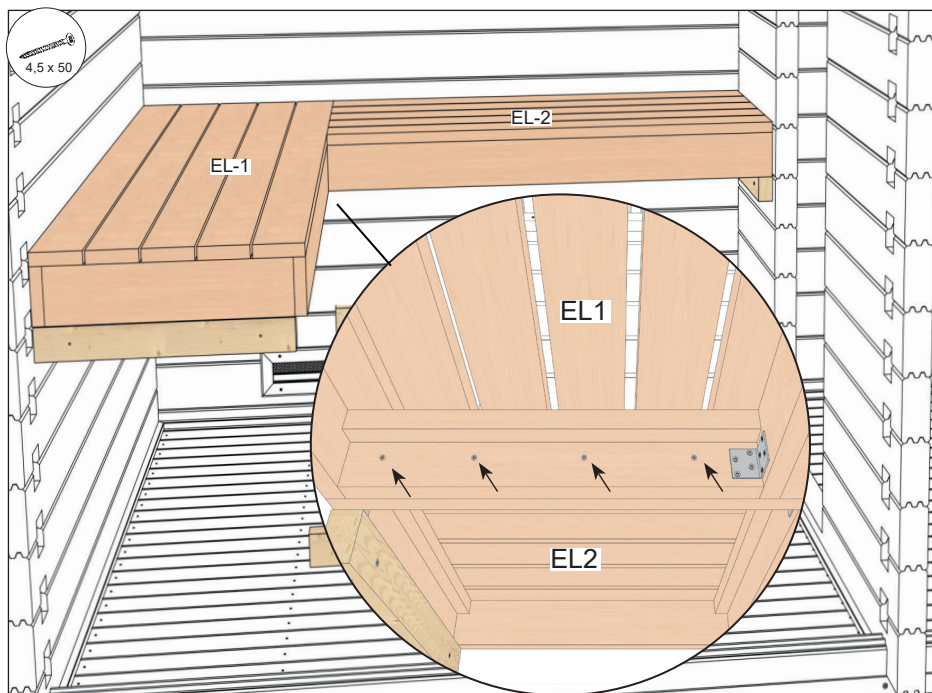

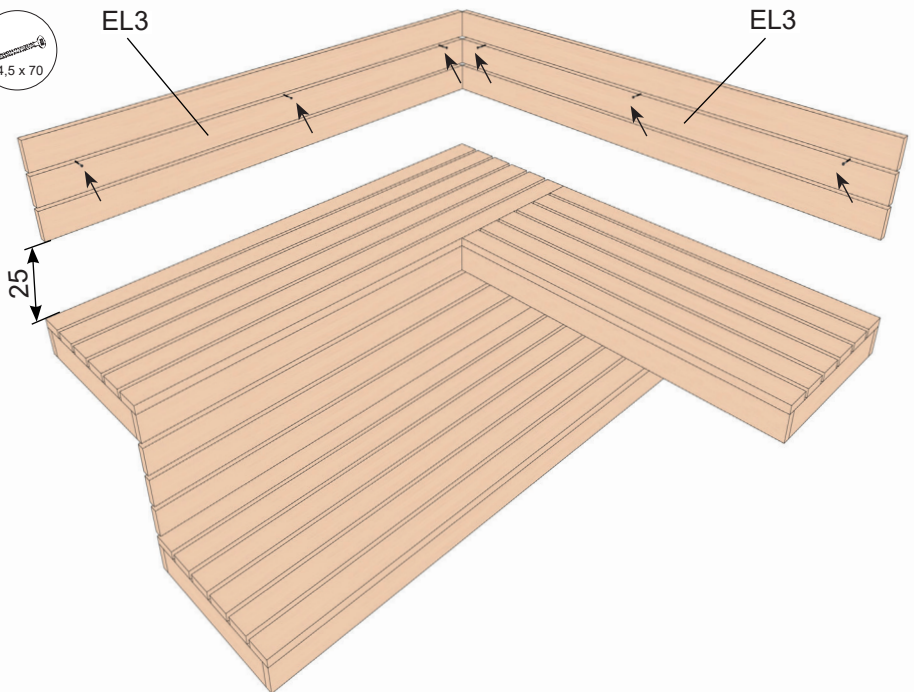
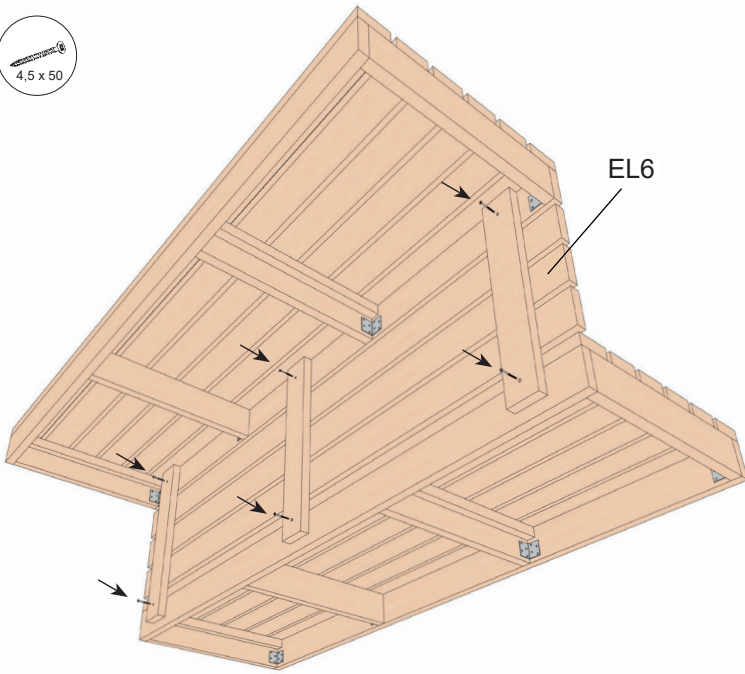

3.12.

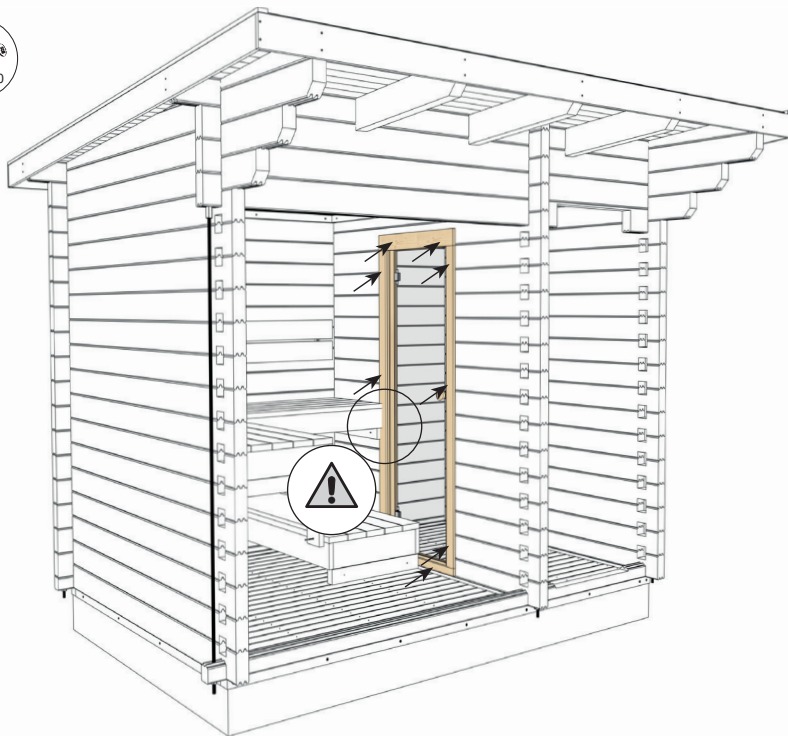
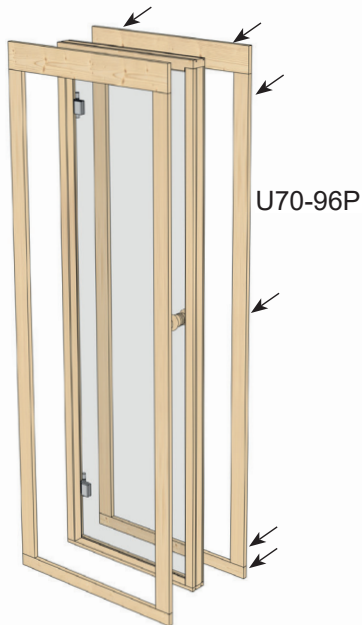

3.13.

